

# A Novel Architecture For Measurement of Temperature, Relative Humidity, and Display of Scrolling Message On LED Display By Using Bluetooth Interface With Arduino Nano.

Mohammad Shaffi<sup>1</sup>, D Ravi Nayak<sup>2</sup>

<sup>1</sup>Assistant Professor, Department of ECE &  
Dadi Institute of Engineering & Technology, Shaffi.khwaza@gmail.com

<sup>2</sup>Assistant Professor, Department of ECE &  
Dadi Institute of Engineering & Technology, ravinayak46@gmail.com

**Abstract**— The measurements of temperature and relative humidity remotely by using the appropriate sensors are not only important in environmental or weather monitoring but also crucial for many industrial purposes. A device for weather monitoring has been developed as described in this paper to monitor the temperature and humidity using digital components. An LED display is also connected to the ARDUINO NANO to display the measurements. The goal of this project is to implement the temperature and humidity system that will perform the observation and monitoring of the servers in the rooms, the temperature and humidity system was implemented by using Arduino Nano Printed Circuit Board (PCB). The system gave results with more accuracy when compared with other systems that measure temperature and humidity as we have used DHT-11 Sensor.

**Keywords**— Arduino Nano, DHT-11( Digital Humidity and Temperature Sensor), Bluetooth, LED Display.

## INTRODUCTION

Now a days Climate plays an important role in human life in industrial as well as house hold applications. A combination of microprocessor technology, operation systems and sensor technology, called embedded systems are widely applied to environment parameters monitoring system of various places, the thermal comfort of human being is influenced mostly by parameters such as, i.e., temperature, air flow, humidity etc... The advancement in current technology made these electronic sensors reliable and capable of monitoring environmental parameters more favourable. Combination of these sensors with data acquisition system gives better approach for temperature, relative humidity etc. In our country places such as agricultural activities, industries, hospitals, storage places etc. require measure and monitor the temperature and humidity for research, production, treatment and diagnosis of the patients, storing food, beverage etc .in weather monitoring, for measuring parameters such as, the temperature and humidity , thus sensors have always been given the task for doing so many activities.

## BLOCK DIAGRAM

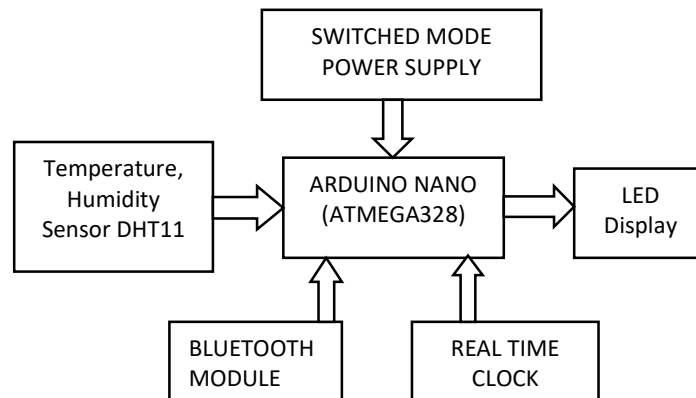

## STEPS OF WORKING

Switch ON the power supply from AC mains and it generates 250V of voltage, and it will be converted into 12V AC by using step down transformer. By Using Bridge Rectifier 12V AC will be converted into 12V pulsating D.C voltage. Later filtering makes this pulsating voltage into pure voltage i.e., removes the noise. The circuit needs 5V D.C, so 7805 voltage regulator is used. The 5V supply is passing through the Arduino Nano and performs the whole operation. The sensor DHT-11 which is used to measure the surrounding temperature and humidity, and spits out a digital signal on the data pin is connected to Port –D of pin number four of Arduino Nano. LED which displays the output is connected with port –D of Arduino Nano. First of all Arduino Nano send the high signal to DHT11 sensor and wait for the response of DHT11 for about 20-25us.. Once DHT11 detects a start signals, it sends a low signal of period 80us to Arduino Nano. Arduino Nano decodes this 40 bit data and separates the value of temperature and humidity. An RTC is used to provide precise data and time which is connected to Arduino Nano. A Bluetooth module is also connected to Arduino Nano which is used for scrolling purpose of acquired output. Finally the total required information can be viewed by servers through LCD/LED.

## HARDWARE AND SOFTWARE USED

### ARDUINO COMPONENT

**Arduino** is a common term in a software and hardware related project, and user community that designs and manufactures computer hardware, and microcontroller-based kits for building devices and interact objects that can sense and control physical devices.

This project is based on microcontroller based designs, produced by several vendors, using various microcontrollers. These systems provide sets of digital and analog Input and output pins that can interface to various expansion boards and other circuits. The boards provide various serial communication interfaces, including Universal Serial Bus on some models, for dumping programs from personal computers. For programming the microcontrollers, the Arduino provides an Integrated Development Environment (IDE) based on a programming language which also supports the languages C and C++.

### ARDUINO NANO

In this chapter, We will study about the Arduino Nano board as it is the most popular board in the Arduino family. In addition, it is the best board to get started with basic knowledge in electronics and coding concepts. Some boards look a bit different from the one given below, but most Arduino have majority of components in common.

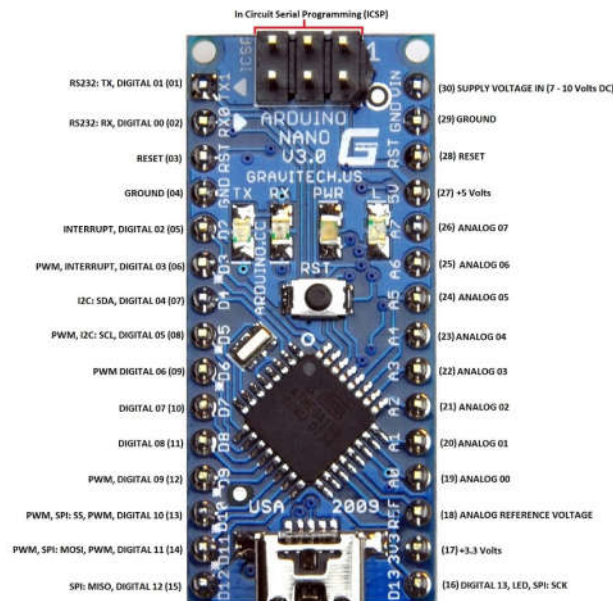

Arduino Nano V3 - Pin Description  
www.CircuitsToday.com

## ARDUINO NANO PIN DIAGRAM

### ATmega328 MICROCONTROLLER

The Atmel AVR core has a rich instruction set of 32 general purpose working registers. All 32 registers are directly connected to the Arithmetic Logic Unit (ALU), allowing independent registers to be accessed in a single instruction executed in one clock cycle. The resulting architecture is code efficient while achieving throughputs up to ten times faster than conventional Complex Instruction Set Computer microcontrollers.

The ATmega328/P is used and this provides the features like: 32Kbytes of In-System Programmable Flash with Read-While-Write capabilities, 1Kbytes EEPROM, 2Kbytes SRAM, 23 general purpose I/O lines, 32 general purpose working registers, Real Time Counter (RTC), three flexible Timer/Counters with compare modes and PWM, 1 serial programmable USARTs , 1 byte-oriented 2-wire Serial Interface (I2C), a 6-channel 10bit ADC (8 channels in TQFP and QFN/MLF packages) , a programmable Watchdog Timer with internal Oscillator, an SPI serial port, and six software selectable power saving modes .it can be operated in two modes The Idle mode in this stops the CPU while allowing the SRAM, Timer/Counters, SPI port, and interrupt system to continue functioning as usual. The Power-down mode of operation saves the register contents but freezes the Oscillator, disabling all other chip functions until the next interrupt or hardware reset occur. In Power-save mode of operation, the asynchronous timer continues to run, allowing the user to maintain a timer base while the rest of the device is sleeping.

The ADC Noise Reduction mode stops the CPU and all I/O modules in the system except asynchronous timer and ADC to minimize switching noise during ADC conversions. In Standby mode of operation, the crystal/resonator oscillator is running while the rest of the device is sleeping. This allows very fast processing with low power consumption. In Extended Standby mode of operation, both the main oscillator as well as the asynchronous timer continue to run.

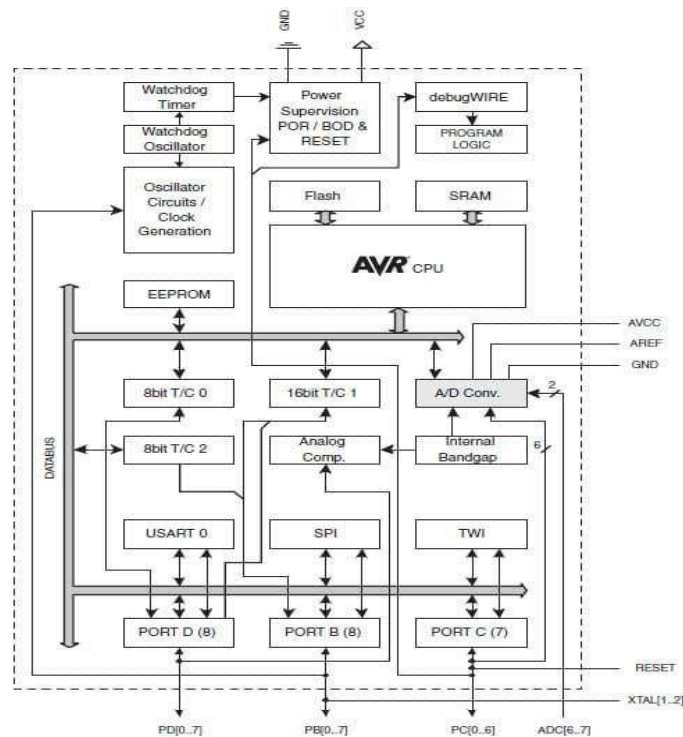

Block Diagram of ATmega328 microcontroller

## BLUETOOTH MODULE

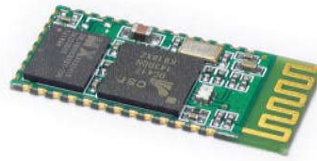

### BLUETOOTH MODULE

HC-05 Bluetooth module is an easy to use Bluetooth SPP (Serial Port Protocol) module, designed for transparent wireless serial connection setup which is used to transfer serial data. Serial port Bluetooth module is a fully qualified Bluetooth V2.0+ EDR (Enhanced Data Rate) and 3Mbps Modulation with complete 2.4GHz radio transceiver and baseband system. It has CSR Blue core 04-External single chip Bluetooth system with CMOS technology and with AFH (Adaptive Frequency Hopping) Feature. It has the footprint as small as 12.7mmx27mm. It is used to simplify your overall design/development cycle.

### SOFTWARE USED IN DISPLAYING OF TEMPERATURE AND HUMIDITY

#### What is Arduino Software

Arduino is first of its kind as an open-source computer hardware and software community. The Arduino Community refers to project and user community that designs and utilizes microcontroller-based development boards for developing user friendly interface modules. These development boards are known as Arduino Modules, which are open-source prototyping platforms used for performing different applications. The simplified microcontroller board comes in a variety of development board packages as shown below.

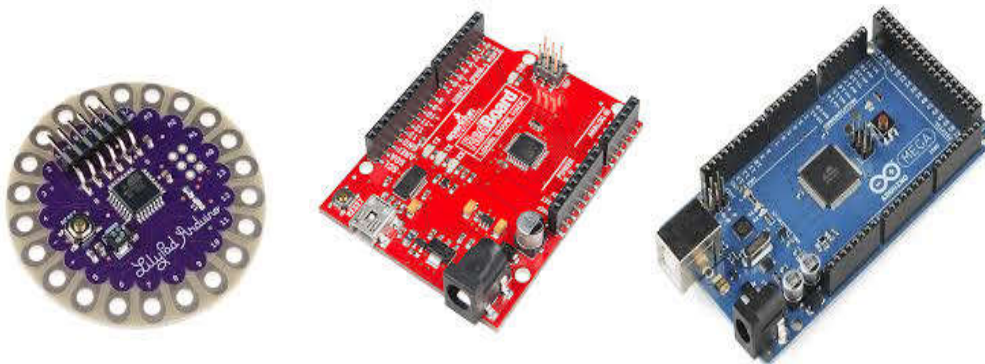

(From left to right) Lilypad, Sparkfun Pro Micro, Arduino Mega

The most common programming approach is to use the Arduino IDE software, which utilizes the C programming language for code developing. This gives you access to an enormous Arduino Library that is constantly growing thanks to a open-source community.

#### Arduino Software (IDE)

The Arduino Integrated Development Environment(IDE) or Arduino Software - contains a text editor for writing code, a text console, and a toolbar with buttons for common functions and a series of menus are provided. It connects to the Arduino and Genuino hardware to upload programs to Atmega-328 and communicate with Arduino Nano.

## Writing Sketches

Programs written using Arduino Software (IDE) are called as **sketches** and These sketches are written in the text editor and are saved with the file extension .ino. The editor has options for cutting/pasting and for searching/replacing text. The message area gives feedback along with saving and exporting , it also displays errors. The console displays text output by the Arduino-IDE Software (IDE), including complete error messages and other information. The bottom right hand corner of the window displays configured board and serial port. The toolbar buttons allow you to upload and verify programs it also help us to create, open, and save sketches, and open the serial monitor.

## DESIGN VERIFICATION

The working of measuring of temperature, Relative humidity and scrolling of messages on a LED Display using Arduino Nano and hardware components such as Digital Humidity and Temperature (DHT-11) sensor and Arduino nano with 328atmega, RTC(Real Time Clock), power supply and Bluetooth module. The Arduino makes the application without any timing issues. The integration and mutual functionality of both the hardware and software makes this system more user friendly and also gives greater performance. In this project we have used three Arduino nano interface boards. First one is used to interface Real Time Clock, Second one is used to interface Bluetooth Module which is used in order to display messages ,circulars etc..and third one is used to interface DHT-11 sensor. Below Figures show the practical implementation of this project which shows Temperature, Relative Humidity and Scrolling of Text which can be changed by using micro Bluetooth app on smart phone which is interfaced to Arduino Nano using Bluetooth module Interface.

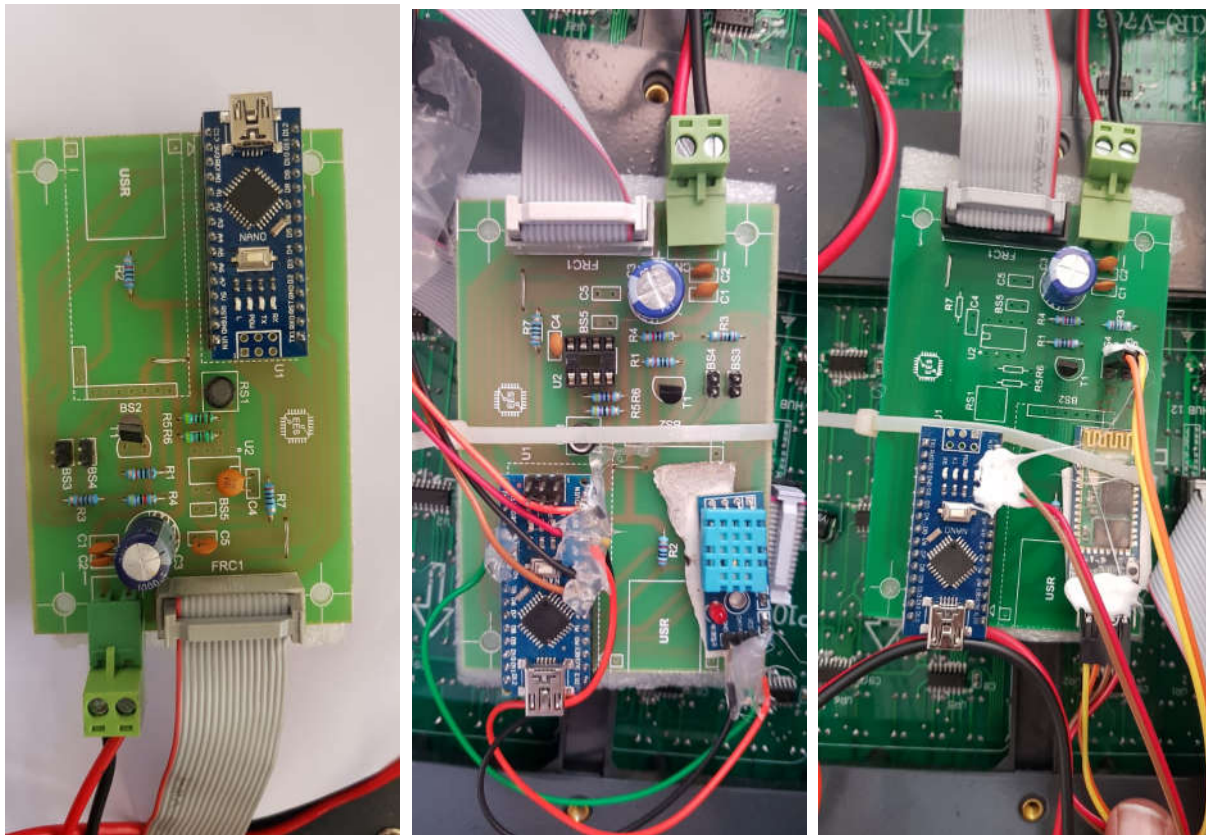

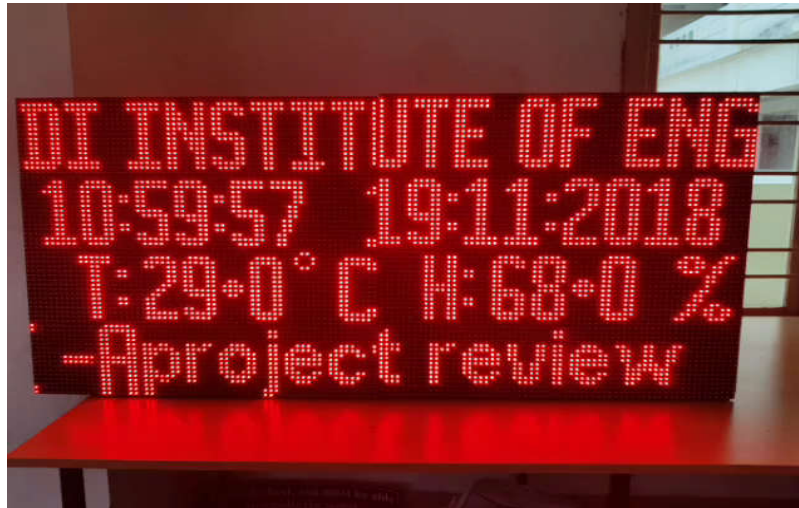

Final Display Board

## CONCLUTION AND FUTURE SCOPE

In this project we have reviewed a various existing techniques of college such as scrolling message, displaying temperature and humidity .By implementing this idea, we can improve the difficulties in industries and the quality of services to the college atmosphere .The system will have latest technology and optimized algorithms with moderate cost. The embedded based application gives the information about the college atmosphere, display of circulars, notification and welcome notes. The proposed system is more user friendly than existing system. And it also gives greater performance.

The advancement in internet and sensor technologies is unlimited and their useful implementation could lead to major breakthrough in the field of embedded system. In future, we can implement simple cashless system harnessing the capabilities of the NFC present in the smart phones or RFID technology for small area measurement

## REFERENCES

- [1]. Akami, P., Oke, A. & Akpomiemie, O., 2015. Impact of environmental factors on building project. ScienceDirect, 11(1).
- [2]. Anon.,2017. ArduinoUnoRev3. [Online] Available at: <https://store.arduino.cc/arduino-uno-rev3>.
- [3]. Anon.,2017. Arduino-Introduction. [Online] Available at: <https://www.arduino.cc/en/guide/introduction>.
- [4]. Anon.,2017. Arduino-Wikipedia. [Online] Available at: <https://en.wikipedia.org/wiki/Arduino>.
- [5]. Sandhu, R., 2016. What is Arduino? A full definition. [Online] Available at: <https://www.lifewire.com/what-is-arduino-2495652> .
- [6]. Anon.,2017. DHT11.pdf. [Online] Available at: <https://akizukidenshi.com/download/ds/aosong/DHT11.pdf> .
- [7].Circuit basics, 2017. How to set up the DHT11 humidity sensor. [Online] Available at: <http://www.circuitbasics.com/how-to-set-up-the-dht11-humidity-sensor-onan-arduino>.

Author Profile



Mohammad Shaffi pursuing Ph.D in the Department of Instrument Technology, Andhra University, Andhra Pradesh, India. His research areas include VLSI Design, Embedded System Design and Image Processing.



D Ravi Nayak pursuing Ph.D in the Department of ECE, University College of Engineering JNTU Kakinada, Andhra Pradesh, India. His research areas include Antennas, Embedded System Design and Signal Processing.